

**Standard, Armless & Ottomans** (All 4 seat items ship as one piece if stationary)

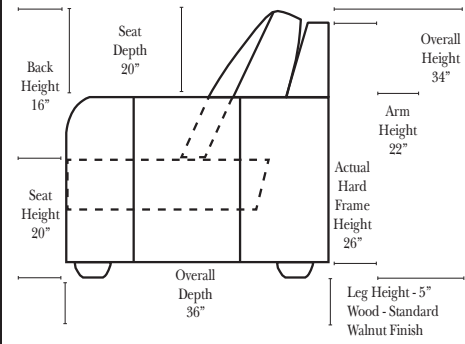
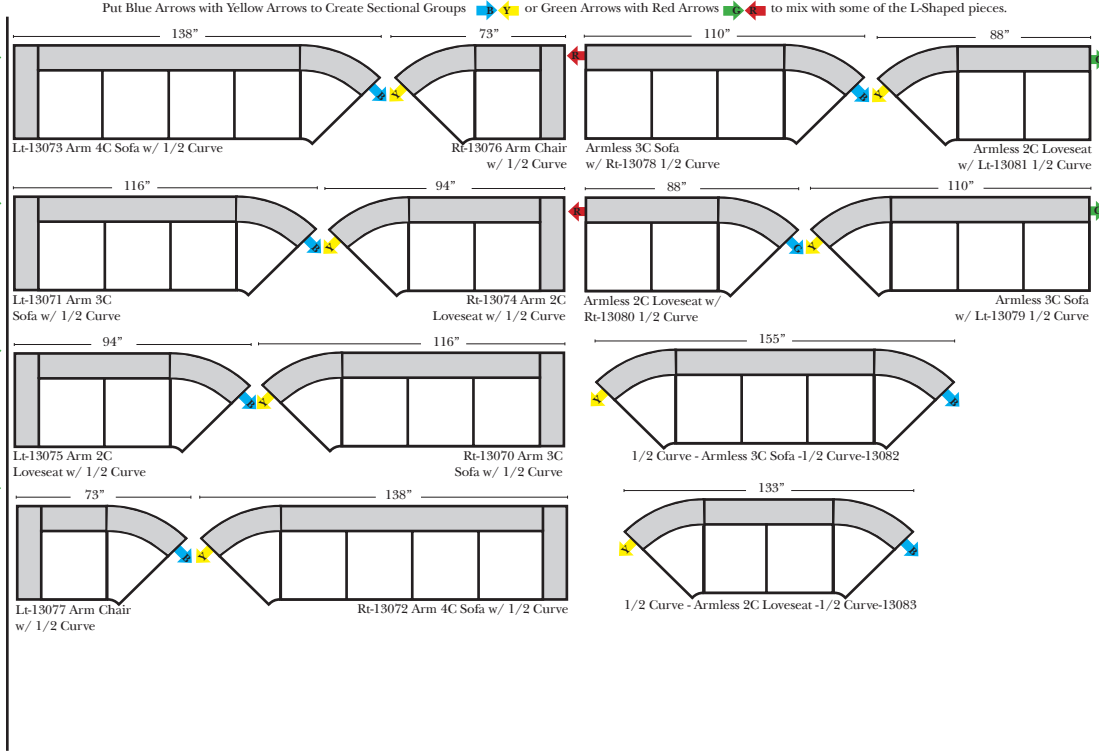
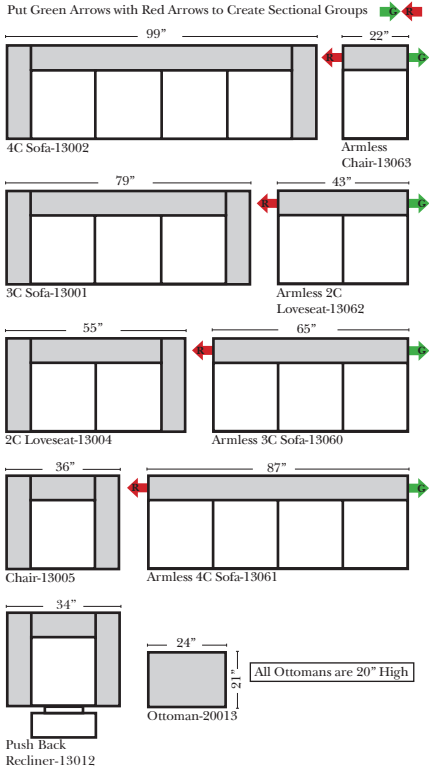

**Standard & Options**

**Standard:**

- Available in Full & Top Grain Leathers
- Available in Luxury Fabrics
- All Hardwood Frames
- Wood Leg Finish (Standard is Walnut)

**Options: (No Additional Charge)**

- No. 33 Firm Foam Cushions
- Wood Leg Finish (Available in Cherry, Chocolate, Espresso, Honey Oak, & Shadow)

**Options: (Additional Charge)**

- Down Seats & Down Backs

**Sleeper Options :** (Sleepers not available for this style)

**L-Shape / 90 Degree Sectional**

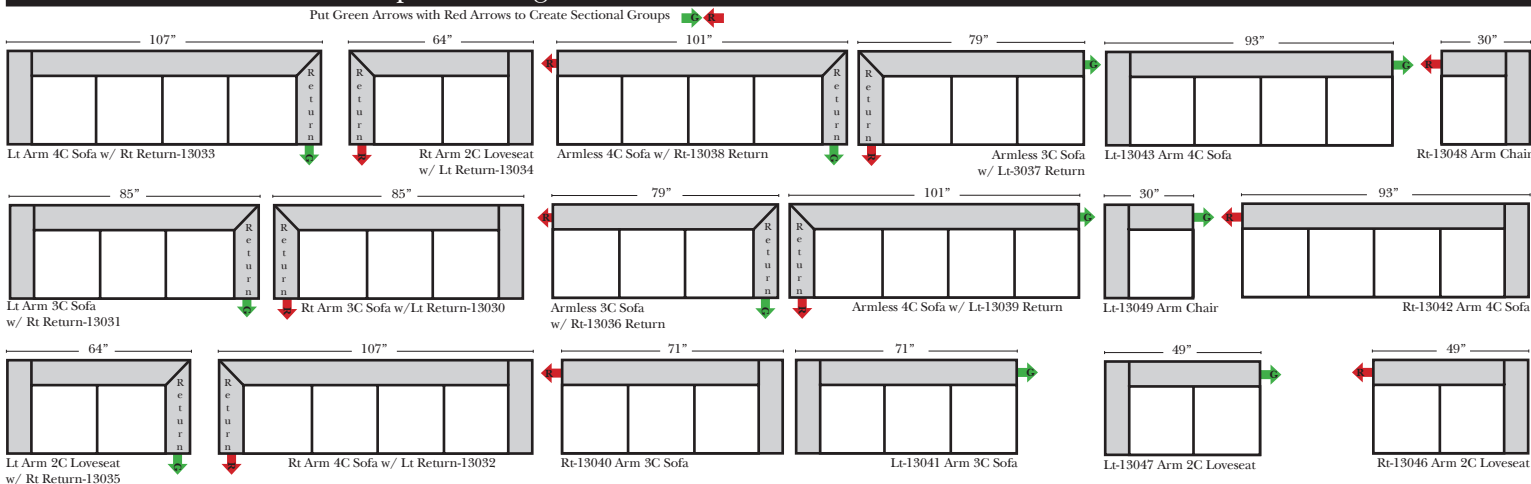

(All 4 seat items ship as one piece if stationary)



**Note:**



All Dimensions are approximate, if accuracy is crucial, please contact us for validation of the dimensions shown. However, a 1" to 2" variance can still apply due to foam and upholstery.

**Chaise & Conversation Sectionals**

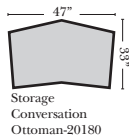
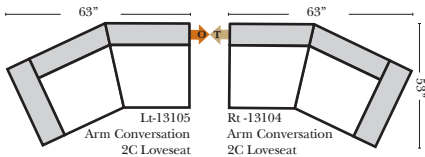
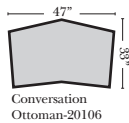
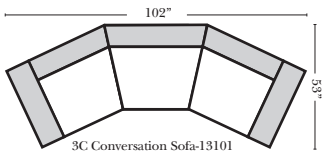
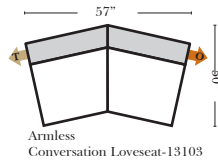
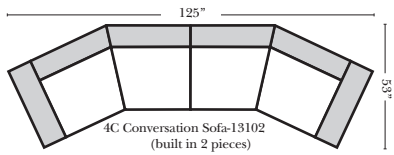
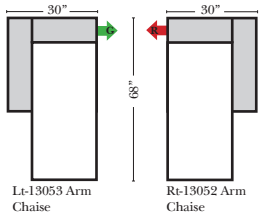
Put Green Arrows with Red Arrows to Create Sectional Groups   
Put Orange Arrows with Tan Arrows to Create Sectional Groups 



**Sleepers**

Put Green Arrows with Red Arrows to Create Sectional Groups   
Put Blue Arrows with Yellow Arrows to Create Sectional Groups 

**Sleepers**  
for this style not available  
for this style

**Suggested Configurations**

v.10.03.16

The Suggested Configurations below are only a sample of what the imagination can create, please enjoy creating the configuration that fits your lifestyle, using the ideas below and from the items on the opposite page.

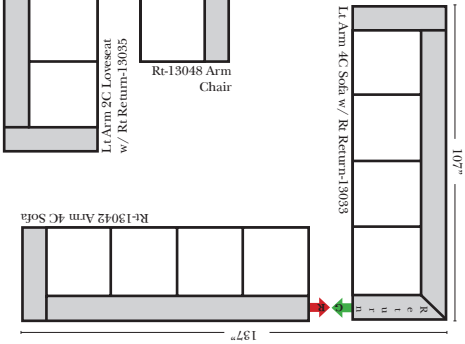
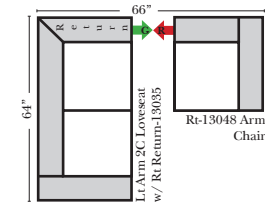
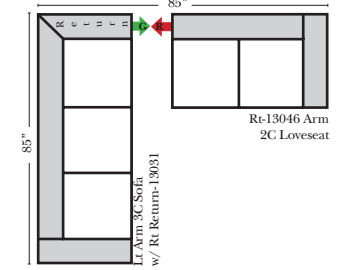
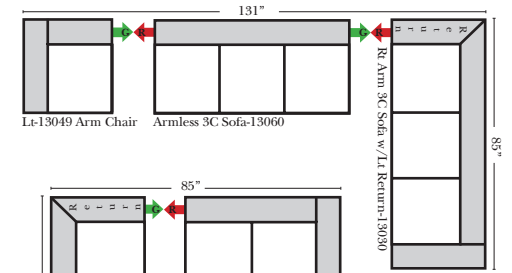
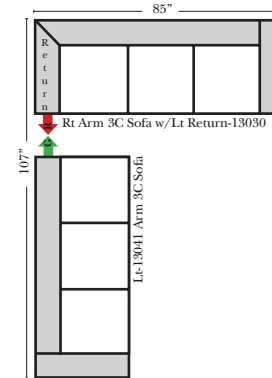
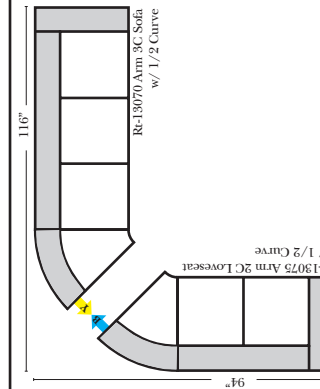

**Sleepers (Cont.)**