

## Standard / Armless

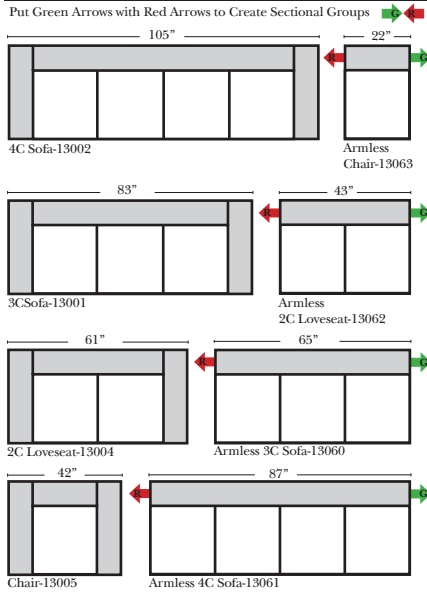

## 2-Piece Curve Sectional / Ottomans

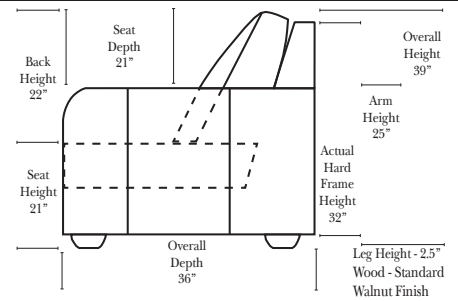
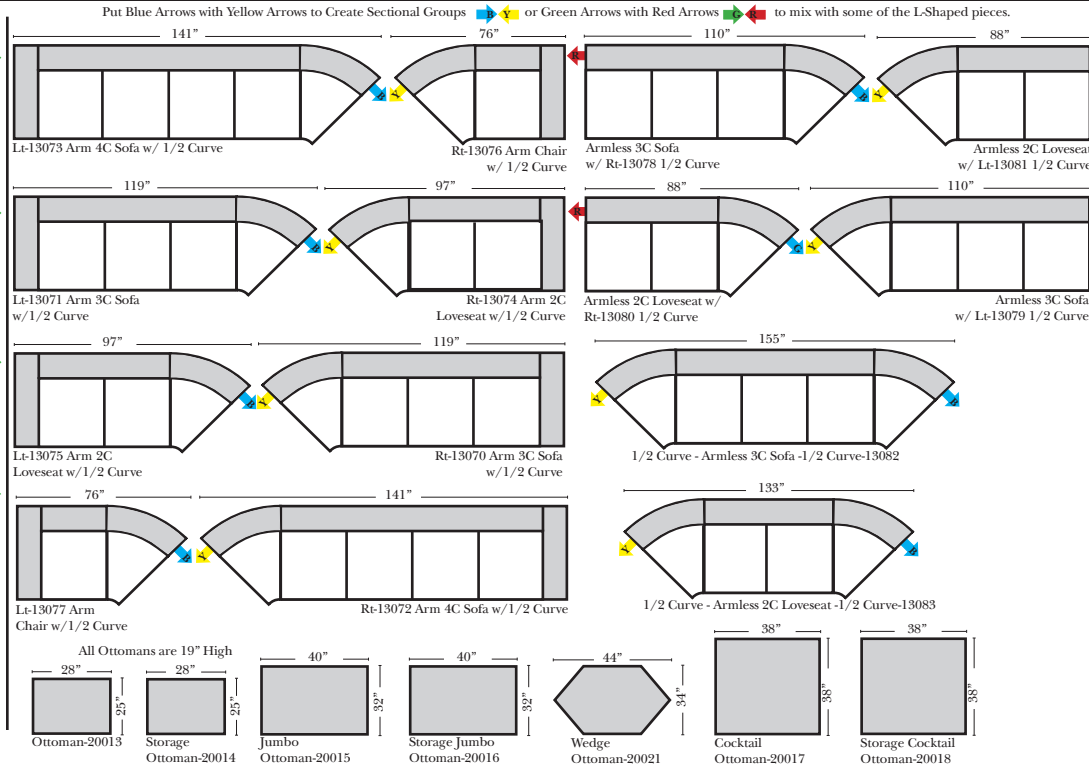

## Feature & Options

### Standard:

- Available in Full & Top Grain Leathers
- Available in Luxury Fabrics
- All Hardwood Frames
- Wood Legs: with standard Walnut finish

### Options Available (No Additional Charges Apply)

- No. 33 Firm Foam
- Wood Leg Finishes - Cherry, Chocolate, Espresso, Honey Oak, Shadow

### Options Available (Additional Charge Apply)

- Add Storage to Ottoman
- Down Seats & Down Backs

### Sleeper Options: (Additional charges apply)

- Full Sleeper available w/ Standard Mattress
- Deluxe Innerspring Mattress: Full
- Air Dream Coil Mattress: Full Only

## 90 Degree / L-Shape Sectional

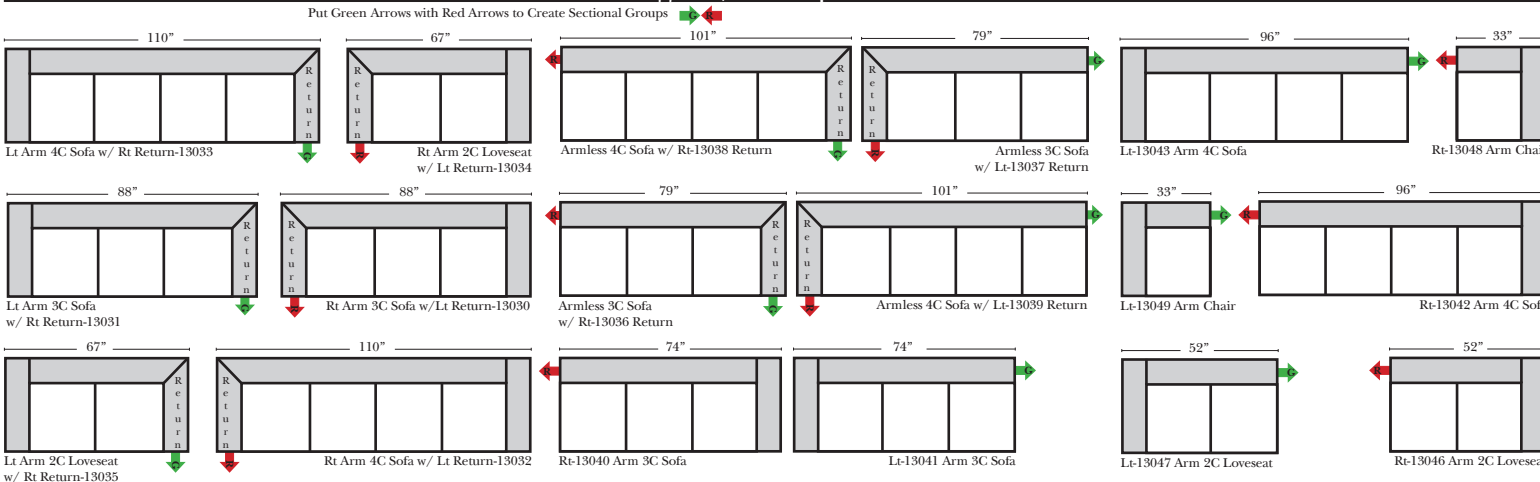

### Note:

All Dimensions are approximate, if accuracy is crucial, please contact us for validation of the dimensions shown. However, a 1" to 2" variance can still apply due to foam and upholstery.

## Chaise & Conversation Sectionals

Put Green Arrows with Red Arrows to Create Sectional Groups  
Put Orange Arrows with Tan Arrows to Create Sectional Groups

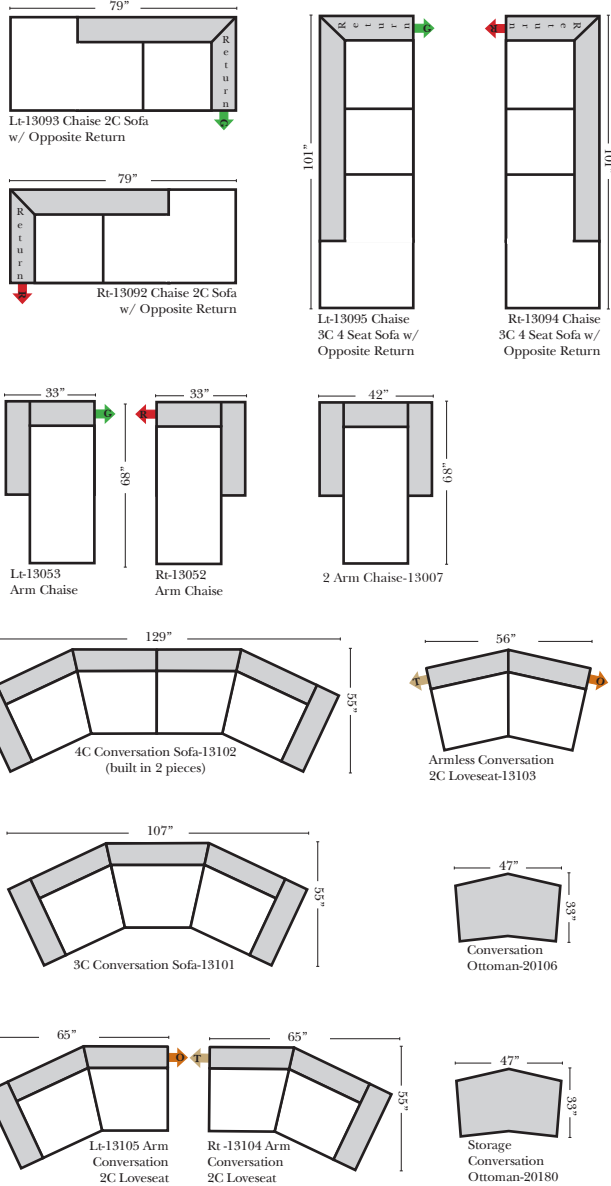

## Sleepers

Put Green Arrows with Red Arrows to Create Sectional Groups  
Put Blue Arrows with Yellow Arrows to Create Sectional Groups

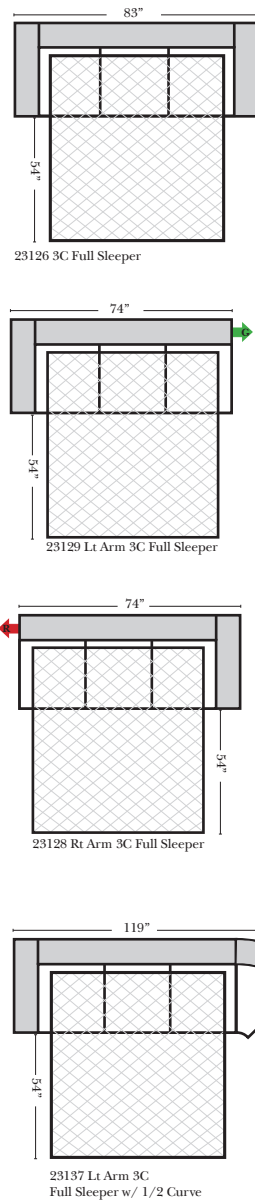

## Suggested Configurations

v.03.05.14

The Suggested Configurations below are only a sample of what the imagination can create, please enjoy creating the configuration that fits your lifestyle, using the ideas below and from the items on the opposite page.

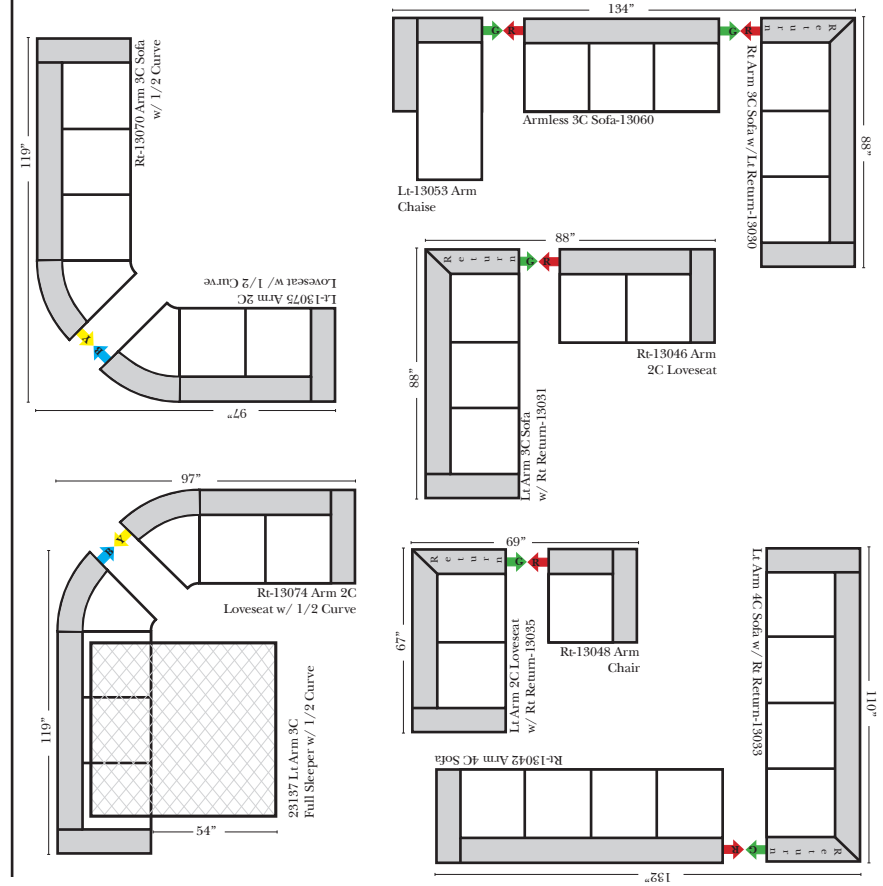

## Sleepers (Cont.)

